

Pattern Name

25cm / 28 cm square

LIBERTY. 150
YEARS

The Patchwork Collective

9 Patch Block

25cm / 28 cm square

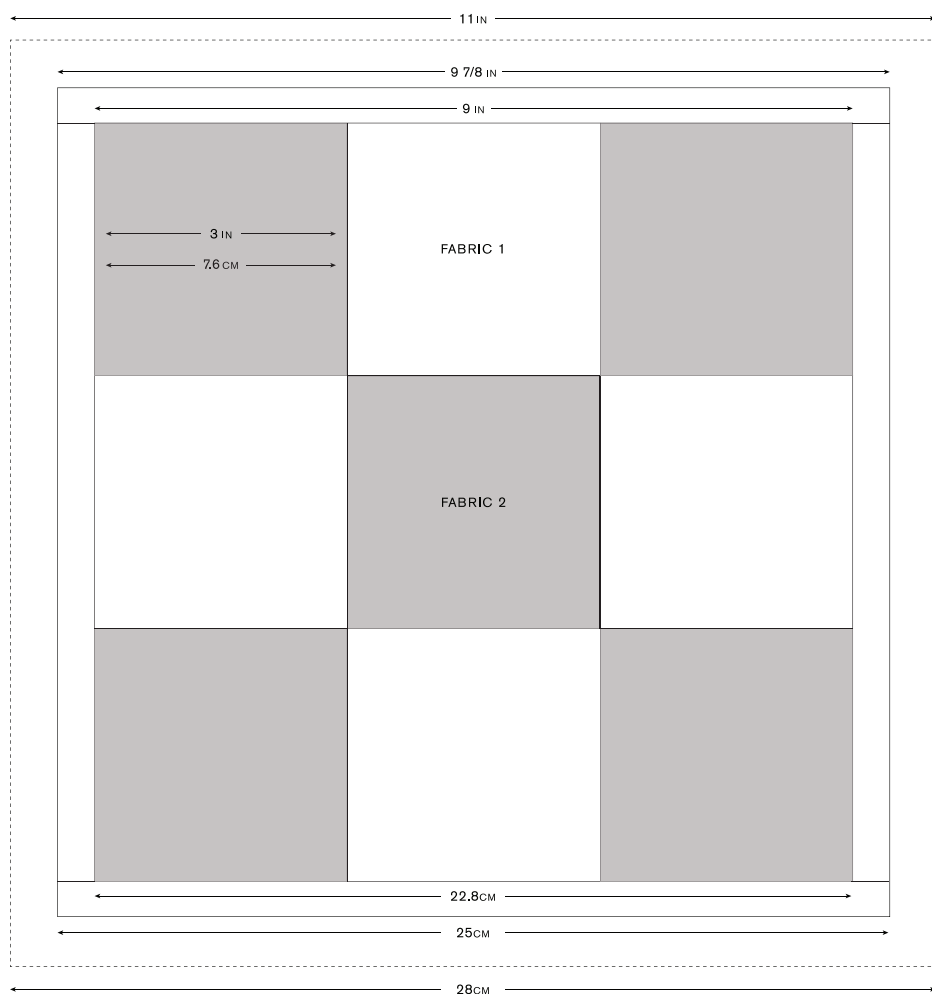

	Imperial	Metric
Fabric 1	Four 3 1/2" squares	Four 9cm squares
Fabric 2	Five 3 1/2" squares	Five 9cm squares
Sashing Fabric	Two strips 1 1/4" x 9 1/2" Two strips 1 1/4" x 11"	Two strips 3.3cm x 24.2cm Two strips 3.3cm x 28cm

9 Patch Block

25cm / 28 cm square

Seam allowance: $\frac{1}{4}$ " or 0.7cm

1. Sew the squares into three rows of three and press seams towards the darker fabrics.
2. Sew the three rows together and press seams open or to one side as preferred.
3. Sash the sides of the block with the shorter strips and press over.
4. Sash the top and bottom of the block with the longer strips and press over.
5. Trim to 28cm square if needed.

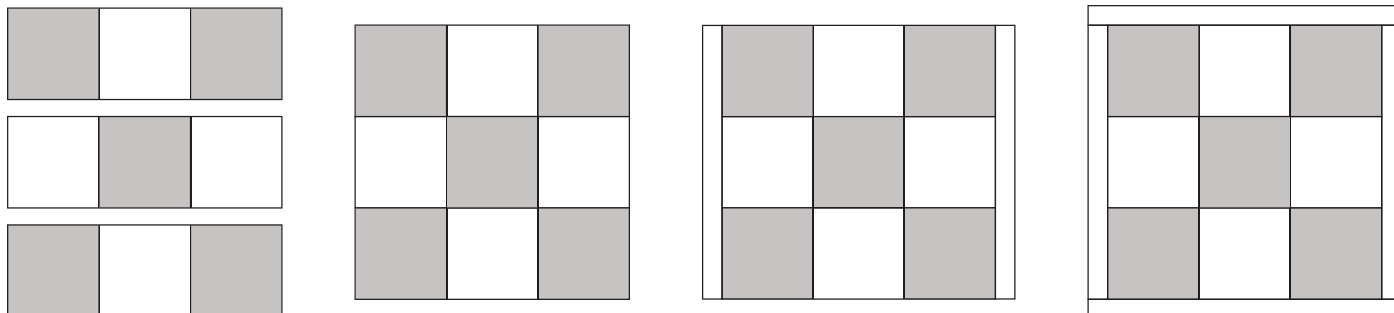

Friendship Star

25cm / 28 cm square

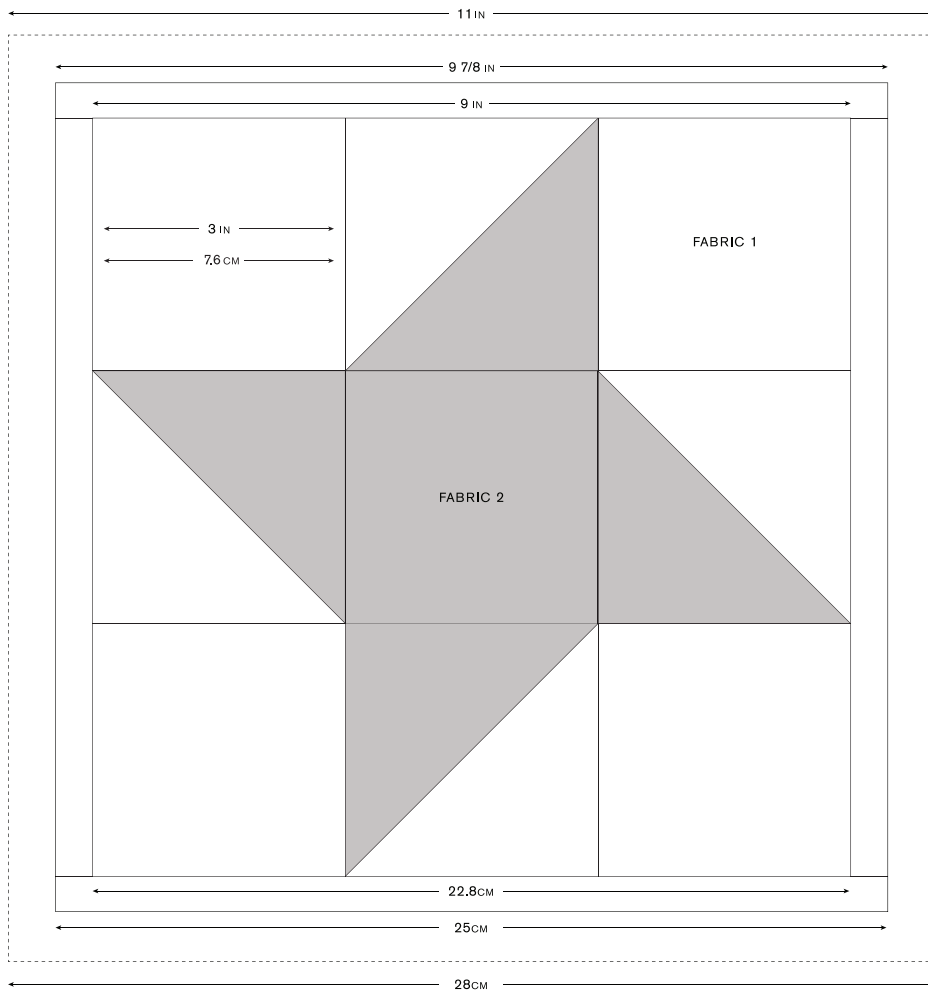

	Imperial	Metric
Fabric 1	Four 3 1/2" squares Two 4" squares	Four 9cm squares Two 10cm squares
Fabric 2	One 3 1/2" square Two 4" squares	One 9cm square Two 10cm squares
Sashing Fabric	Two strips 1 1/4" x 9 1/2" Two strips 1 1/4" x 11"	Two strips 3.3cm x 24.2cm Two strips 3.3cm x 28cm

Friendship Star

25cm / 28 cm square

Seam allowance: $\frac{1}{4}$ " or 0.7cm

1. Place the fabric 1 and fabric 2 larger squares right sides together, each pair containing one of each fabric.
2. Draw a diagonal line on the back of one of each pair of squares.
3. Sew seam lines $\frac{1}{4}$ " or 0.7cm either side of the drawn line.
4. Cut into two along the drawn diagonal line.
5. Press open and trim to $3\frac{1}{2}$ " square / 9cm square to make four half square triangle units (HSTs).

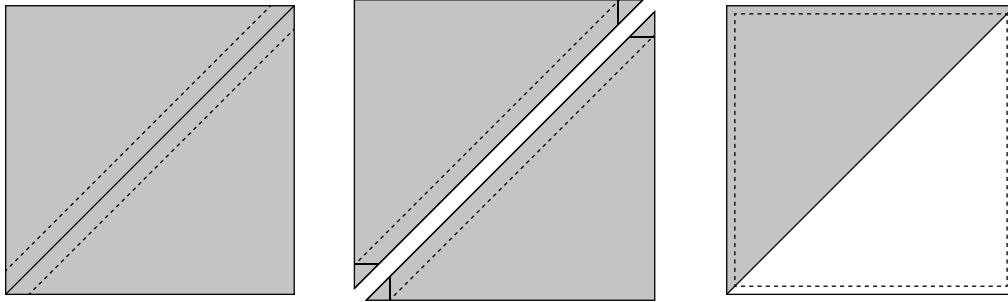

6. Sew the remaining squares and the HSTs into three rows of three and press seams away from the HSTs.
7. Sew the three rows together and press seams open or two one side as preferred.
8. Sash the sides of the block with the shorter strips and press over.
9. Sash the top and bottom of the block with the longer strips and press over.
10. Trim to 28cm square if needed.

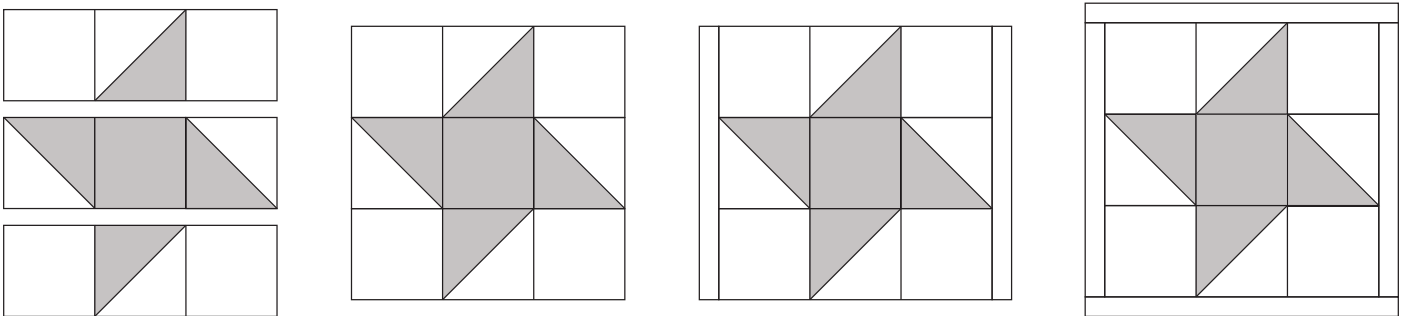

Ohio Star

25cm / 28 cm square

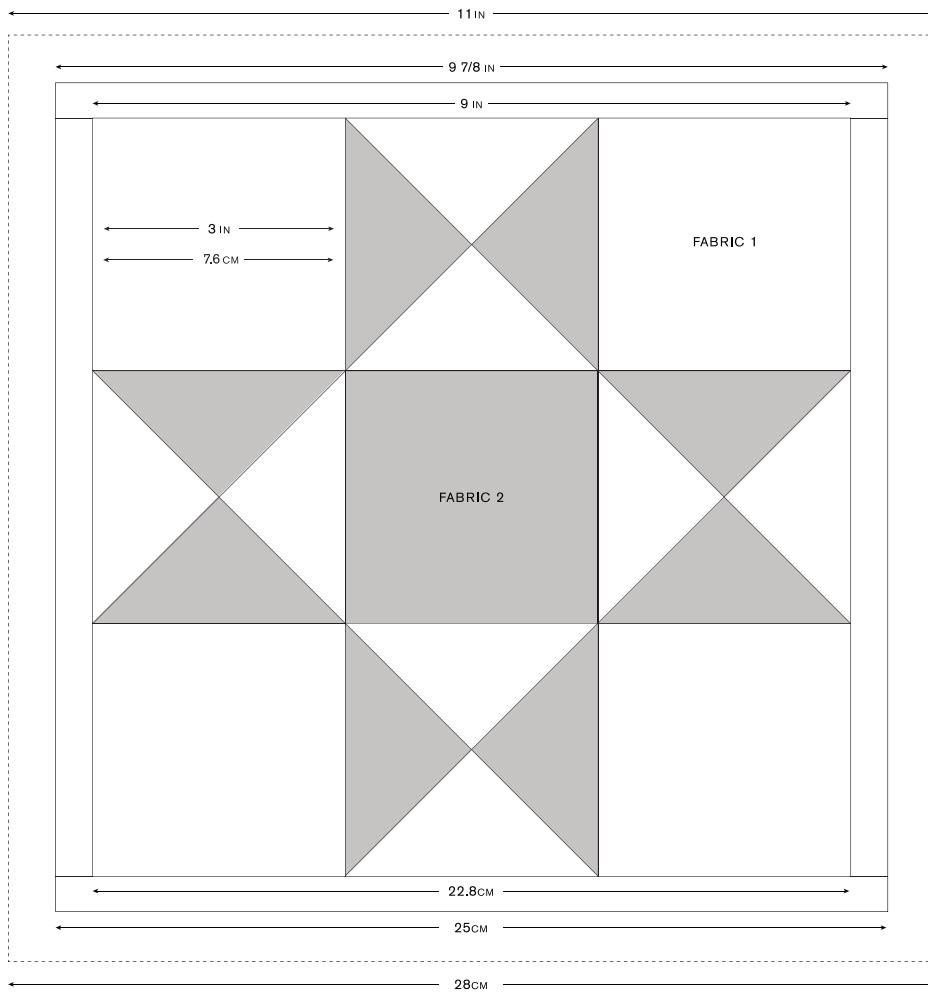

	Imperial	Metric
Fabric 1	Four 3 1/2" squares Four 4 1/2" squares	Four 9cm squares Four 11.5cm squares
Fabric 2	One 3 1/2" square Four 4 1/2" squares	One 9cm square Four 11.5cm squares
Sashing Fabric	Two strips 1 1/4" x 9 1/2" Two strips 1 1/4" x 11"	Two strips 3.3cm x 24.2cm Two strips 3.3cm x 28cm

Ohio Star

25cm / 28 cm square

Seam allowance: 1/4" or 0.7cm

1. Place the fabric 1 and fabric 2 larger squares right sides together, each pair containing one of each fabric.
2. Draw a diagonal line on the back of one of each pair of squares.
3. Sew seam lines 1/4" or 0.7cm either side of the drawn line.
4. Cut into two along the drawn diagonal line.
5. Press open, pressing seams towards the darker fabrics.
6. Place two of these half square triangle units (HSTs) right sides together with the dark fabric opposite the lighter.
7. Draw a diagonal line on the back of one of the HSTs.
8. Sew seam lines 1/4" or 0.7cm either side of the drawn diagonal line.
9. Cut in half along the drawn diagonal line.
10. Press open and trim to 3 1/2" square / 9cm square to make four quarter square triangle units (QSTs).

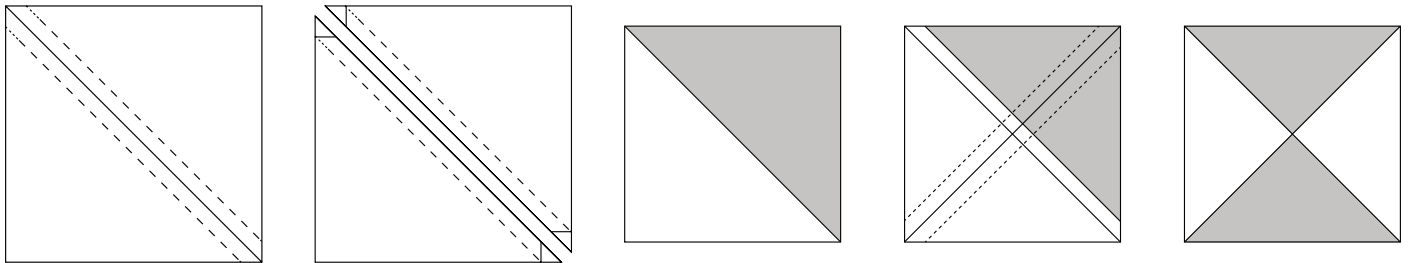

11. Sew the remaining squares and the QSTs into three rows of three and press seams away from the QSTs.
12. Sew the three rows together and press seams open or two one side as preferred.
13. Sash the sides of the block with the shorter strips and press over.
14. Sash the top and bottom of the block with the longer strips and press over.
15. Trim to 28cm square if needed.

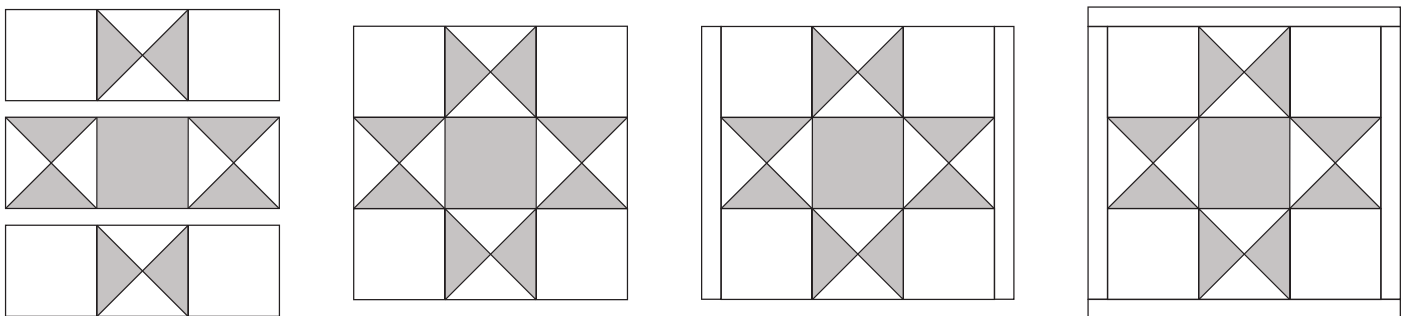

Sawtooth Star

25cm / 28 cm square

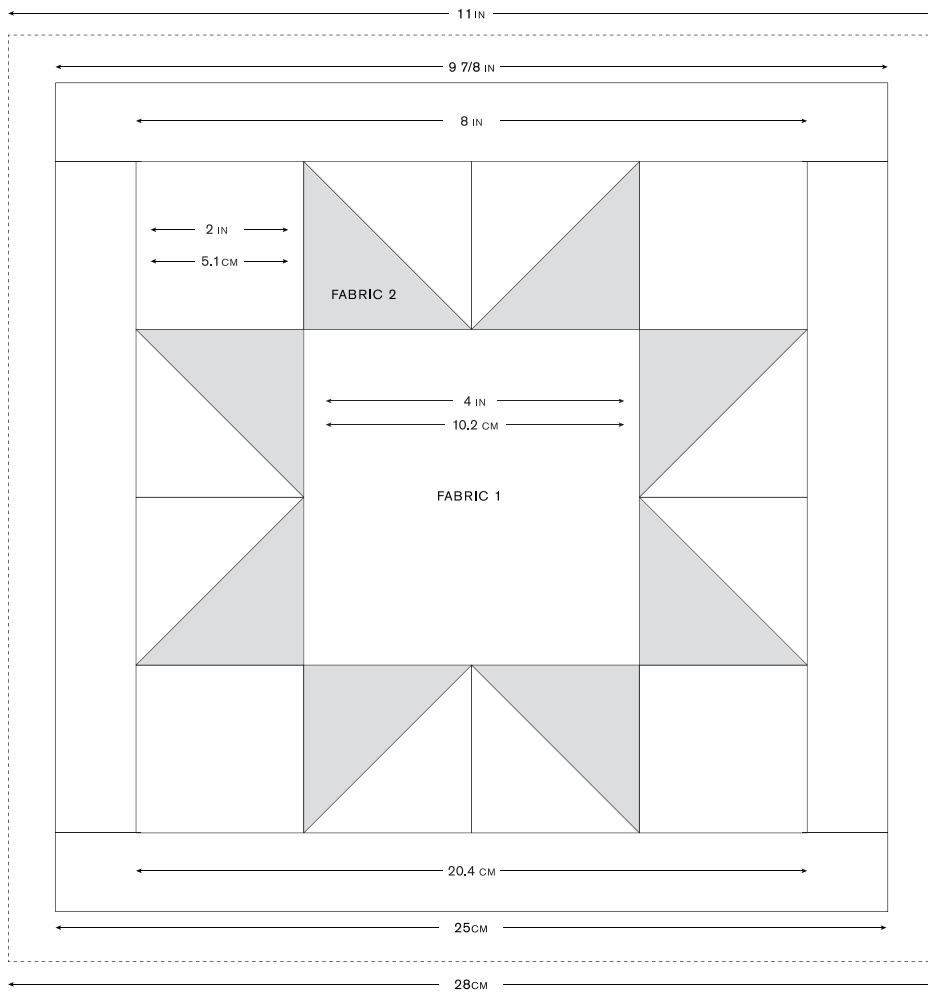

	Imperial	Metric
Fabric 1	Four 2 1/2" squares One 4 1/2" square Two 3" squares	Four 6.5cm squares One 11.6cm square Two 8cm squares
Fabric 2	Two 3" squares	Two 8cm squares
Sashing Fabric	Two strips 1 3/4" x 8 1/2" Two strips 1 3/4" x 11"	Two strips 4.5cm x 21.8cm Two strips 4.5cm x 28cm

Sawtooth Star

25cm / 28 cm square

Seam allowance: $\frac{1}{4}$ " or 0.7cm

1. Place the fabric 1 and fabric 2 $3\frac{3}{8}$ / 8cm squares right sides together, each pair containing one of each fabric.
2. Draw a diagonal line on the back of one of each pair of squares.
3. Sew seam lines $\frac{1}{4}$ " or 0.7cm either side of the drawn line.
4. Cut into two along the drawn diagonal line.
5. Press open and trim to $2\frac{1}{2}$ " square / 6.5cm square to make eight half square triangle units (HSTs).

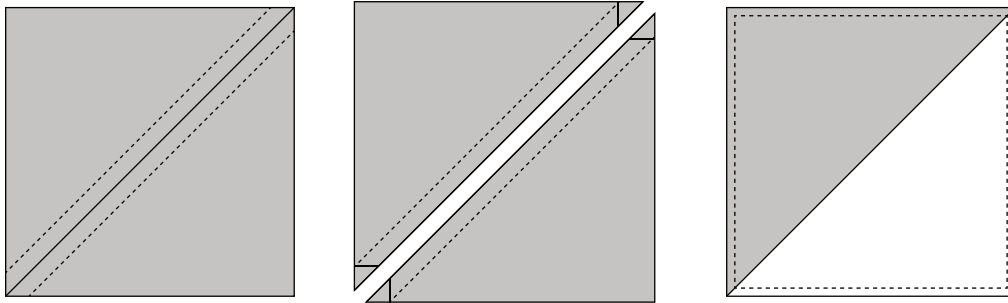

6. Sew the QSTs into pairs and sew fabric 1 small squares onto each end of two of those pairs.
7. Sew the remaining two pairs to either side of the fabric 1 large square.
8. Press seams away from the QSTs in each row.
9. Sew the three rows together and press seams open or two one side as preferred.
10. Sash the sides of the block with the shorter strips and press over.
11. Sash the top and bottom of the block with the longer strips and press over.
12. Trim to 28cm square if needed.

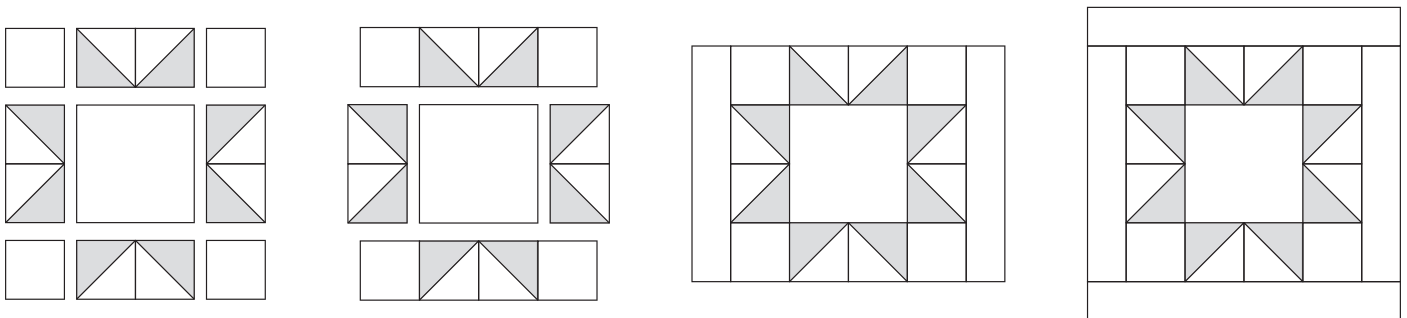

Log Cabin Block Pattern

28 cm square

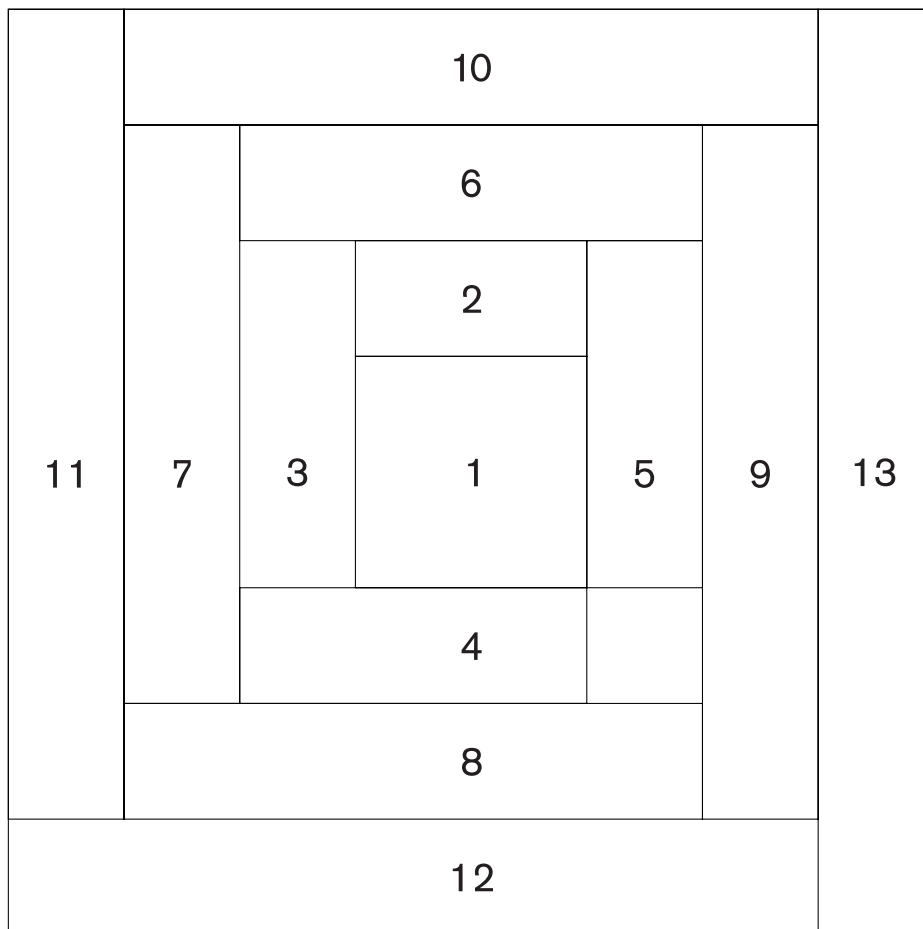

This pattern contains the instructions to make a log cabin quilt block. Traditionally, the center square is made in red to represent a hearth surrounded by the logs of a log cabin. The two sides are often made in contrasting light and dark values. This block also looks great scrappy; just try to have a contrast between the logs so they don't blend.

Cut fabrics for the block to the following sizes.

Fabric 1. – Center square 3" x 3" (7.6cm x 7.6cm)

Fabric 2. – 1.75" x 3" (4.4cm x 7.6cm)

Fabric 3. – 1.75" x 4.25" (4.4cm x 10.8cm)

Fabric 4. – 1.75" x 4.25" (4.4cm x 10.8cm)

Fabric 5. – 1.75" x 5.5" (4.4cm x 14cm)

Fabric 6. – 1.75" x 5.5" (4.4cm x 14cm)

Fabric 7. – 1.75" x 6.75" (4.4cm x 17.1cm)

Fabric 8. – 1.75" x 6.75" (4.4cm x 17.1cm)

Fabric 9. – 1.75" x 8" (4.4cm x 20.3 cm)

Fabric 10. – 2.25" x 8" (5cm x 20.3cm)

Fabric 11. – 2.25" x 9.5" (6cm x 25cm)

Fabric 12. – 2.25" x 9.25" (6cm x 25cm)

Fabric 13. – 2.25" x 11" (6cm x 28cm)

- Work out from the middle joining the pieces using a ¼" (0.6cm) seam.
- Sew in numerical order from 1 through 13 as in diagram.
- Press seams away from the middle after each fabric is joined.
- Trim threads and trim block making sure it measures 11" (28cm) finished.

Le Moyne Star

28 cm square

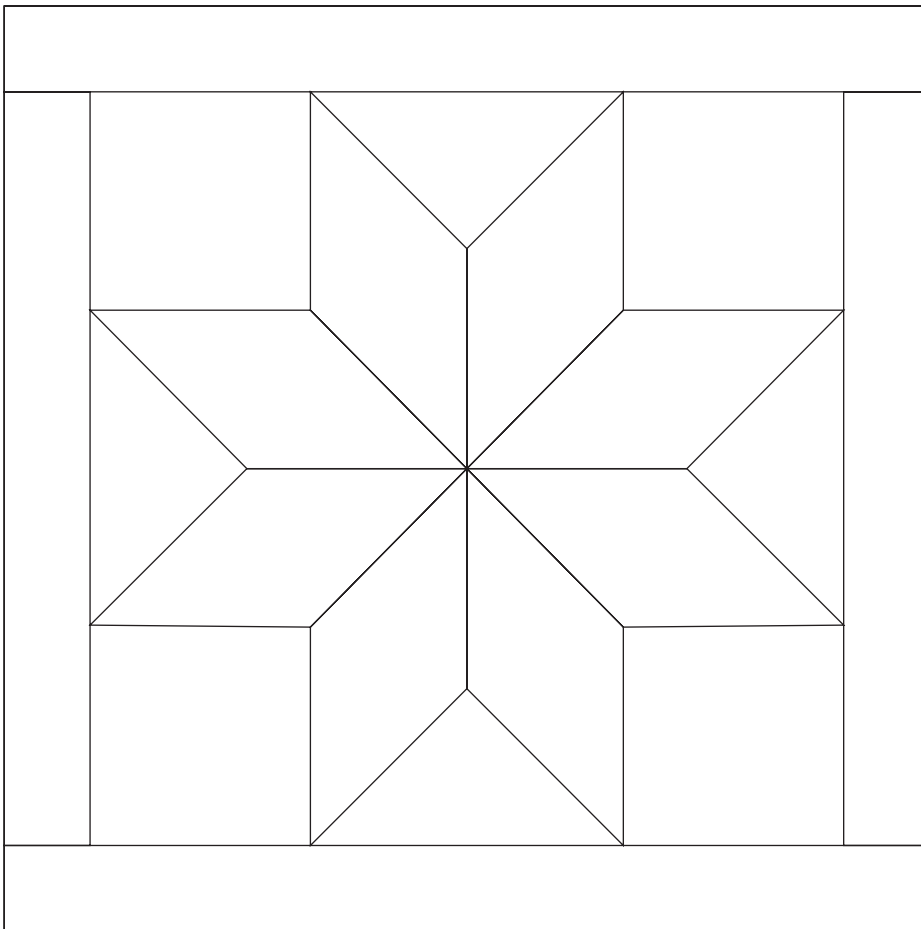

This pattern is suited for someone who has English paper piecing experience. This pattern requires an intermediate knowledge of quilting techniques and terminology. The quilt and block diagrams portrayed are virtual images. The layout and look of your project may differ when using actual fabric.

Sewing Supplies		Sewing Equipment
Total Required	EPP Paper Shapes	Hand Sewing Needles – (Size 10 Applique Or Milliners Straws) Cotton Thread - 50 Wt Or Finer Fabric Glue Pen For Basting Straight Pins, Scissors, Fabric Marking Pen / Pencil, Fabric Clips, Thread Conditioner, Thimble Rotary Cutting Equipment – Mat, Ruler, Cutter Sewing Machine
8	2 1/2" Diamonds - 45° (6.4cm)	
4	2 1/2" Half Square Triangles (6.4cm)	
4	2 1/2" Squares (6.4cm)	
Acrylic Template Set with 3/8"(1cm) seam allowance or Template Plastic to make your own from provided template sheet in this pattern		

Le Moyne Star

28 cm square

Fabric Key / Requirements

Star Fabric – you can use 1 or 2 colours

25cm x 110cm WOF

(10" x 44") a Long quarter

Background Fabric

25cm x 110cm WOF

(10" x 44") a Long quarter

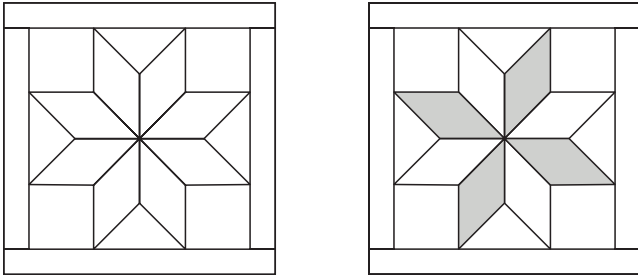

Making Instructions

The centre of the block is English paper pieced.

The diagrams in the pattern below show assembling the centre star in one colour, you may wish to alternate the diamonds in two colours.

For the best results press your fabric before cutting.

On the wrong side of the fabric, position the templates as required and draw around the outer edges; this will be your cutting line.

Basting fabric around paper pieces

Glue basting your fabric to the paper templates is recommended for speed and accuracy; however, traditional thread basting can be used if preferred.

Top Tip - wrap the fabric around your pieces in the same direction to ensure that the pieces will nest together and make it easier for you when sewing together and allow the pieces to lay flat.

I tend to work around the shapes anti clockwise as shown below.

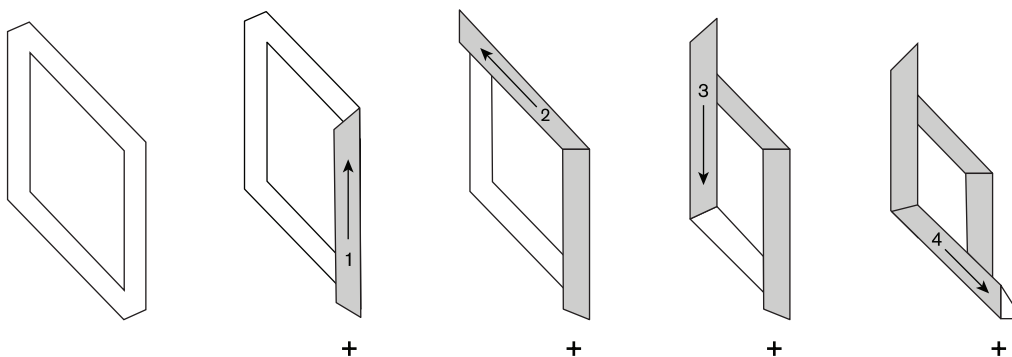

The Centre / basting start part of the shapes are marked with a cross, repeat for all 8 diamonds.

Le Moyne Star

28 cm square

Baste 4 Triangles and 4 Squares from the background fabric as shown below:

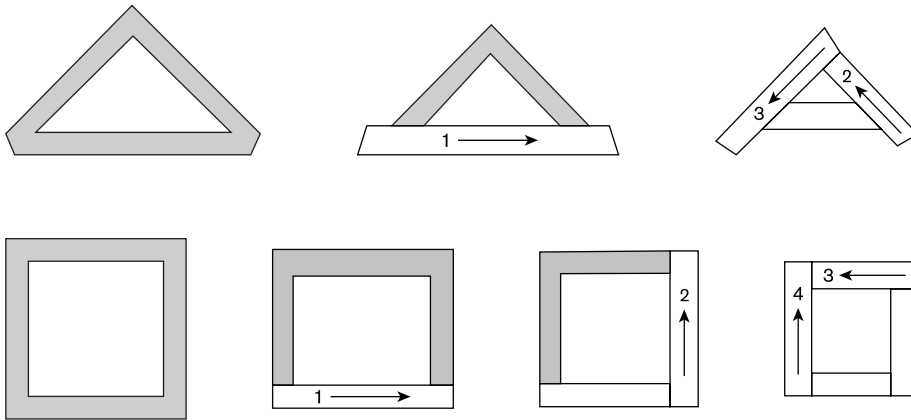

Assembly of EPP Blocks

Once you have cut and basted the EPP shapes they are ready for stitching together, using a whip stitch.

Top Tip – Place your needle in at 90° and this will make sure minimum stitching shows on the right side.

If you are sewing a light and dark fabric together, I recommend matching your thread to the lighter fabric.

1. With right sides together stitch two diamonds together, starting from the centre point marked with a cross. Repeat so you have 4 pairs of diamonds.
2. To each of these diamond units stitch the triangles and squares. Take care to stitch the square to the right as shown in diagram. You will create 4 units the same.
3. Next, starting from the centre stitch two of these quarter units together. Repeat with the other two quarter units.

1.

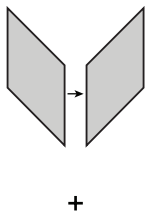

+

2.

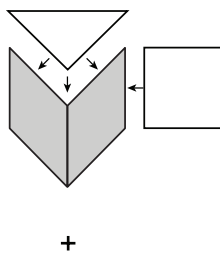

+

3.

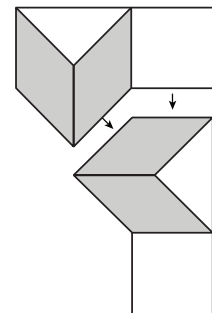

Le Moyne Star

28 cm square

4. Join the two halves together, ensuring the centre points are lined up. Once complete, press your block. Remove papers and press again, this will reveal a $\frac{3}{8}$ " (1cm) seam allowance to sew the sashing to.

5. Cut 2 x $9\frac{1}{4}$ " x 2" (23.5cm x 5cm) strips from background fabric

With Right sides together, pin the sashing strips to the left- and right-hand sides of the block. Stitch with a $\frac{3}{8}$ " (1cm) seam allowance using your sewing machine.

Top Tip – stitch the seam with the block at the top so you can stitch across the fold line to avoid losing the points of the star.

Press your seams towards the sashing strips

6. Cut 2 x $11\frac{3}{4}$ " x 2" (29.6 x 5cm) strips from background fabric

With Right sides together stitch to the top and base of the block with a $\frac{3}{8}$ " (10cm) seam allowance.

Take extra care to not lose the point of your star. Press your seams towards the sashing strips.

7. Trim your finished block will finish at 11" x 11" square (28cm x 28cm)

4.

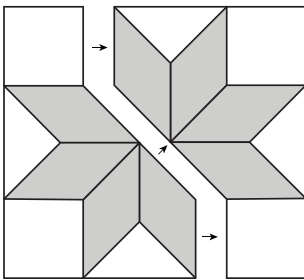

5.

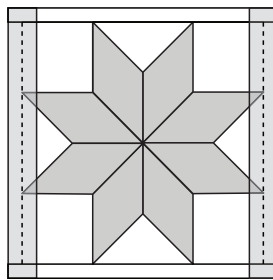

6.

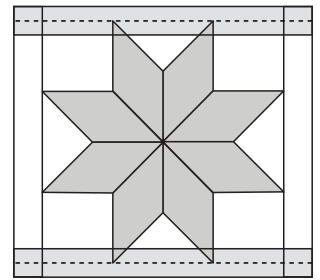

Le Moyne Star

28 cm square

When printing template pages please check your printer is set to actual size, 100%.

A test square has been provided for you to check.

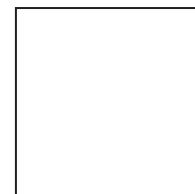

2.5cm Test Square

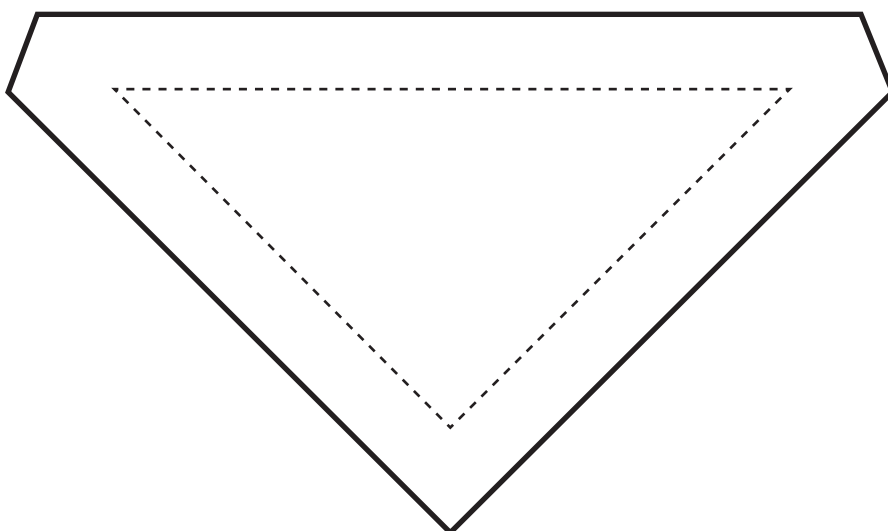
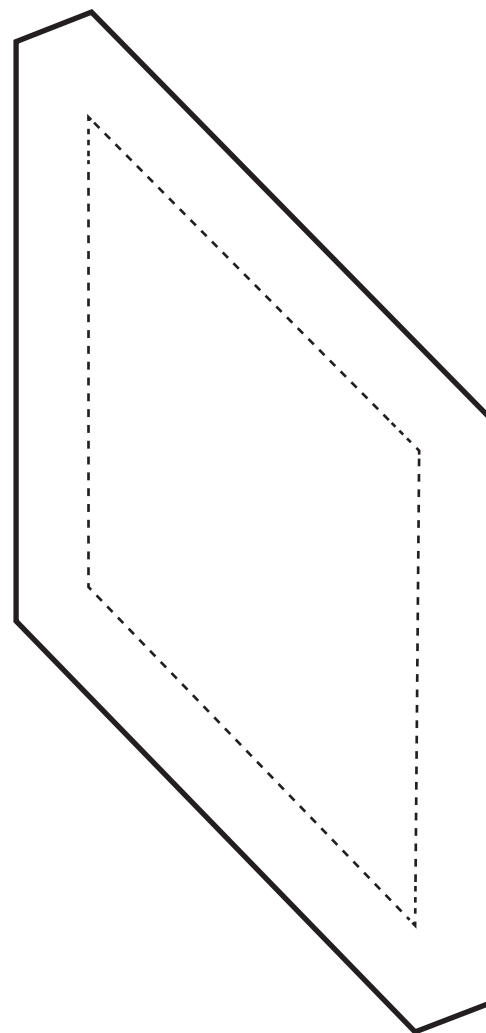
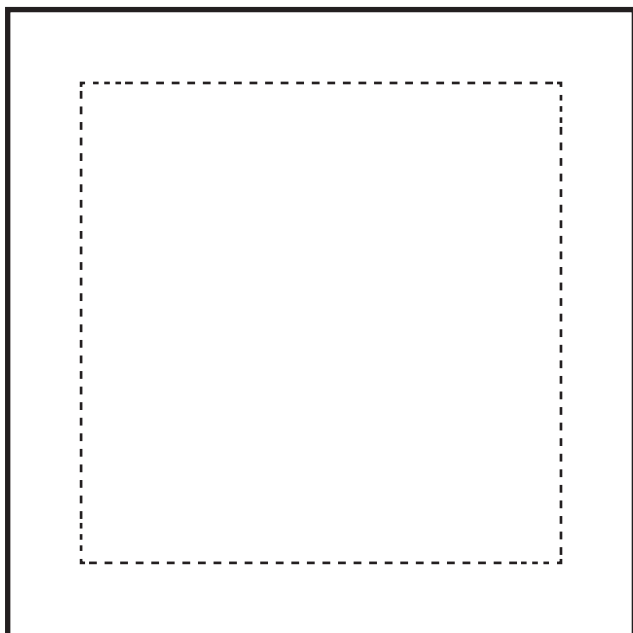

Le Moyne Star

28 cm square

When printing template pages please check your printer is set to actual size, 100%.

A test square has been provided for you to check.

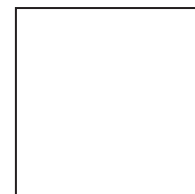

2.5cm Test Square

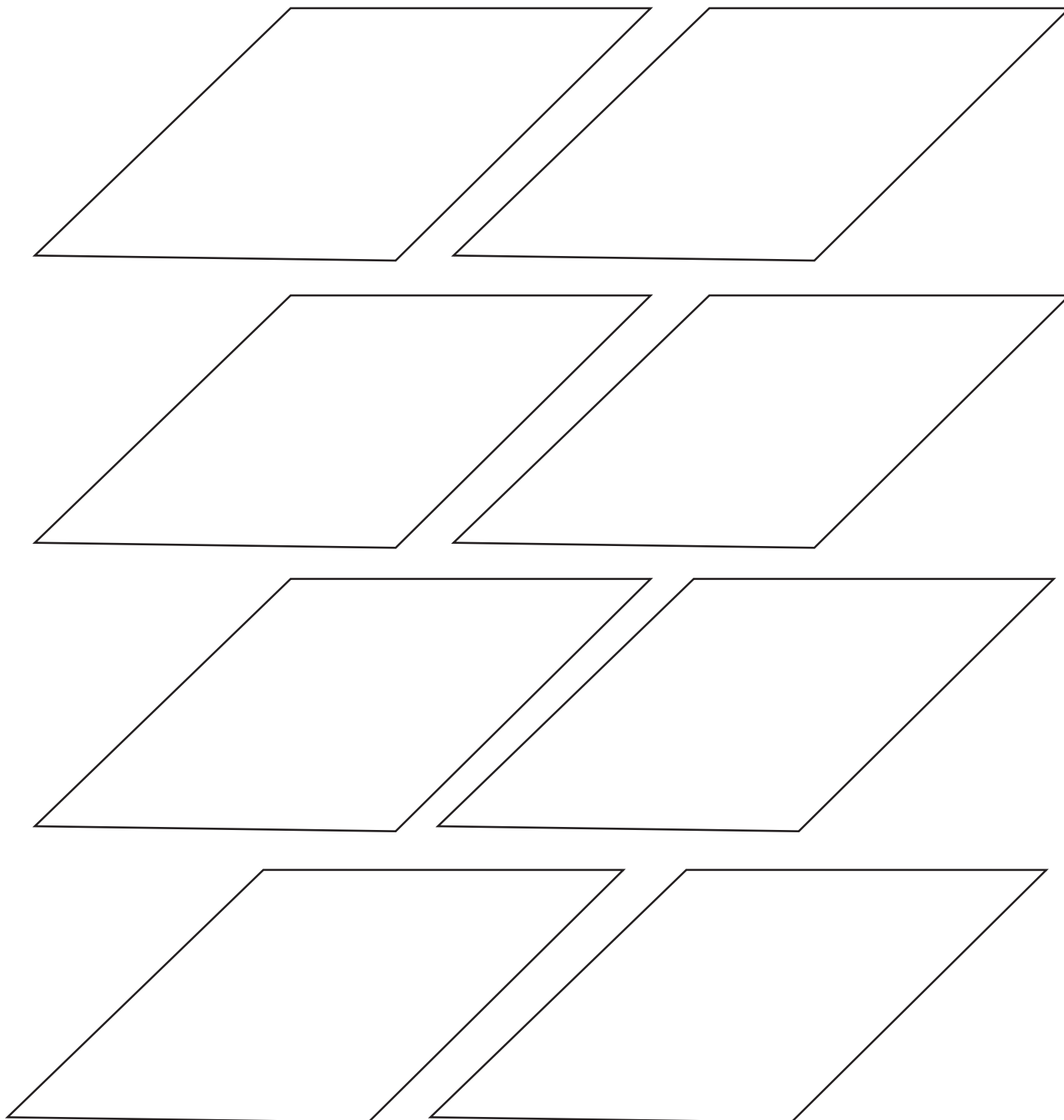

Le Moyne Star

28 cm square

When printing template pages please check your printer is set to actual size, 100%.

A test square has been provided for you to check.

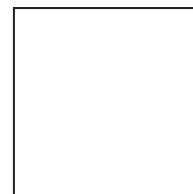

2.5cm Test Square

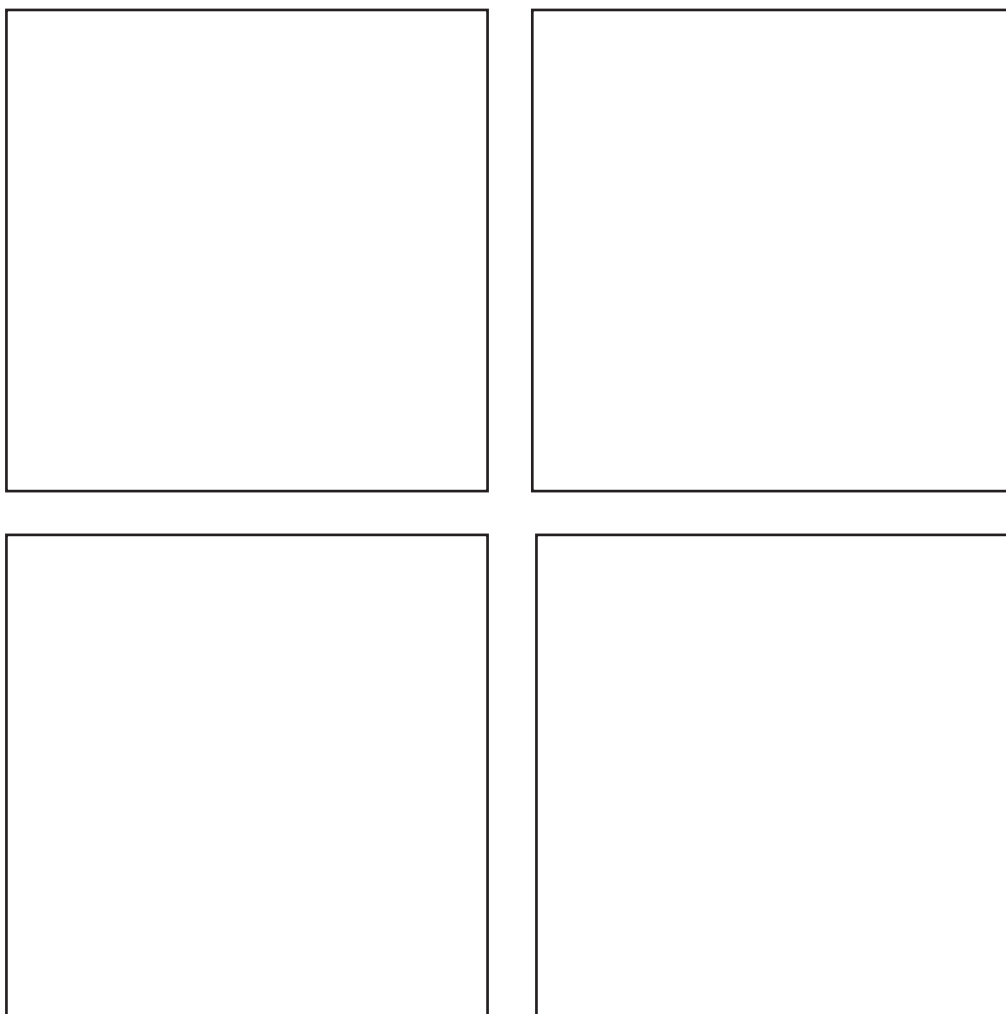

Le Moyne Star

28 cm square

When printing template pages please check your printer is set to actual size, 100%.

A test square has been provided for you to check.

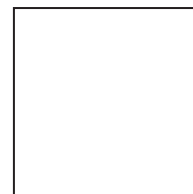

2.5cm Test Square

